

**TASKI**<sup>®</sup>

The **ULTIMATE**  
Cleaning Machines™

swingo  
**250µmicro**



Now everyone can  
achieve a professional  
floor cleaning result



# The swingo 250µmicro delivers the cleaning performance of a machine with the ultimate in convenience, ease and simplicity of a mop.

Now everyone can achieve a professional floor cleaning result.



## Improve your customer experience

Your guests, diners and patients constantly make decisions based on their assessments. Dirty floors are usually indicative of poor standards, higher safety risks and high risk of poor compliance. Mechanising your floor cleaning will make a big difference for the better.

You work hard to create a memorable experience for your guests and diners. First impressions count, make a change and mechanise your floor cleaning. Upgrade to the new swingo 250µmicro. It will transform the appearance of your floors, your guests & diners will really notice.

Healthcare providers know how patients, residents and the public value a clean and hygienic establishment. Your patients and residents will really notice the difference which will keep them feeling safe and protected.



## Protect your brand

The risk of injury from slip fall and the health risk from infections is serious. Failed hygiene standards & audits are warning signs of little or no infection control. Unhygienic mops and buckets can be a hygiene risk especially from contaminated mop heads. It's a well known fact that single bucket mopping can cross contaminate as the solution becomes loaded with soilage and microorganisms. Unless mops are thoroughly laundered at high temperature or disposed of, microorganisms can quickly multiply. Bad odours from mops are a clear sign of a hygiene risk.

Pride in your establishment and brand reputation mean everything. With immaculate guest washrooms and safe and spotless kitchen and food preparation areas that will pass any audit the swingo 250µmicro makes one pass cleaning easy. Time to throw away the mop.



## Protect people and ensure safety

You want to protect your customers, guests and patients whilst safeguarding your brand. TASKI scrubber driers remove up to 65% more water than mopping.

Floors left wet resoil much quicker as well as being an obvious slip fall risk. The swingo 250µmicro ultra-compact design quickly and safely cleans and deals with spillages to ensure the highest hygiene standards. Less soilage = less germs.

Less water = drier, safer floors that stay clean longer.

The safe parking position means furniture and obstacles can be moved without the need to bend or risk the machine falling over. No cable to worry about means you can clean whenever. Time to throw away the mop!



# The swingo 250µmicro is a brilliant replacement for mopping, delivering outstanding results with superior ergonomics and safety



## More effective cleaning results

TASKI scrubber driers remove up to 5 x times more soilage than mopping. A combination of increased cleaning pressure and superior water recovery means floors are visibly cleaner.



## Superior cleaning pressure

Up to 10 x times cleaning pressure means mechanical cleaning is far superior to manual cleaning. Powerful and efficient digital motors ensure the swingo 250µmicro quickly removes stubborn soilage in one pass. Twister pads can improve results further and even restore neglected floors.



## Superior water pickup

Even the best wet mopping systems leave an unsafe level of water residue. Wet floors mean high risk of slip fall. A powerful digital vacuum motor ensures up to 65% more soiled water is recovered leaving floors safely clean and dry.



## Reduction in cleaning costs

One pass cleaning means no repeat cleans and no need to wait for floors to dry. With labour over 80% of total cleaning costs, the swingo 250µmicro saving can reduce total cleaning costs by up to 70%.



## Water and chemical reduction











The swingo 250µmicro's super efficient water distribution means that 6,500L of water and associated chemicals are saved every year. That's a 80% reduction compared to mopping. The swingo 250µmicro isn't just a more efficient answer, it's also a more sustainable solution.

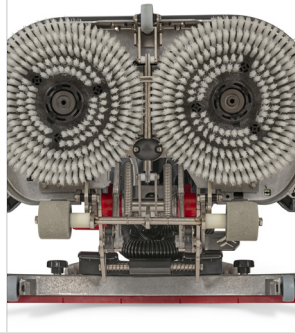

## Safer and more ergonomic

The foot operated brush and squeegee levers means no bending over and the parking mode means the machine can be safely positioned if unattended. With its safe parking position, low handle weight and convenient transport mode the swingo 250µmicro is so simple to use. Clean faster and smarter, not harder.

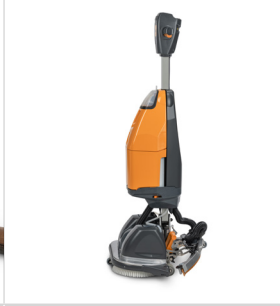
The swingo 250micro, just simply better. Time to throw away the mop...for good

Simple and intuitive	Ergonomic and comfortable	Lightweight and hygienic	Power and performance	Effectiveness and control
				
<p>Simple dashboard with intuitive controls. Battery life indicators. On/off, vacuum on/off, water on/off.</p>	<p>Full height adjustable for comfort, control and ergonomics.</p>	<p>Easy to remove, fill and clean water tanks. Easy to clean and keep hygienic.</p>	<p>Powerful and long lasting lithium Li-ion battery with fast charging and extra long life.</p>	<p>Low RPM with good brush pressure makes for effective soilage removal.</p>
Efficiency and sustainability	Agility and safety	Ease of use	Stability and convenience	Flexibility and simplicity
				
<p>Fully adjustable water distribution. Cover more space with less water.</p>	<p>In the unlikely event of contact, non-marking soft touch bumper guide protects fixtures and fittings.</p>	<p>Foot operated floor brush and squeegee mechanisms. No bending required.</p>	<p>Unique parking mode ensures safe upright parking whilst in use. No bending or unsafe practices when furniture or obstacles are encountered.</p>	<p>Brush for simplicity or pad option for full flexibility. The Twister green pad is available for outstanding results.</p>

More soilage & water removed in less time for cleaner safer floors.

Battery status

Vacuum (on/off)

Water (on/off)

Yellow start button



Orange parking button

Height adjustment lever

Left and right control levers



Orange parking button for safe parking



Efficient squeegee with 2 guide wheels and 3 floor wheels



Foot operated brush and squeegee mechanism



3L recovery tank with clear cover and ball float cut off

Easy to fill 2.2L clean water tank



Non-marking soft touch bumper guide



Low 140RPM and high brush pressure

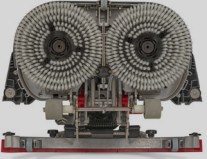

Fully adjustable water flow. Up to 682m<sup>2</sup>/tank



2 x 80mins batteries. 1hr recharge time



**TASKI**<sup>®</sup>The **ULTIMATE**  
Cleaning Machines™**swingo 250µmicro****Article code**

SH7524889

**Model**

TASKI 250µmicro Starter kit

**Technical specification****Metric****Imperial**

Productivity (m <sup>2</sup> /hr / ft <sup>2</sup> /hr)	1,320	14,208
Working width (cm / inches)	44	17.3
Solution tank (L / US gal)	2.2	0.58
Recovery tank (L / US gal)	3	0.79
Battery autonomy (mins)	60-80	60-80
Recharge time (hrs @ 80%)	1	1
Weight RTU with battery & water (kg / lb)	25	55.1
Brush pressure (g/cm <sup>2</sup> / lb/inch)	20.10	0.28
Brush speed (RPM)	140	140
Typical coverage per tank	682	7,341
Coverage per charge (m <sup>2</sup> / ft <sup>2</sup> )	2,150	23,142

(Machine supplied complete with 2 x batteries, charger, and 2 brushes)

For more information go to [www.TASKI.com](http://www.TASKI.com)





**TASKI**

The **ULTIMATE**  
Cleaning Machines



TASKI is one of four core areas of the Diversey business.

TASKI The ULTIMATE Cleaning Machines  
For more information, visit [www.taski.com](http://www.taski.com) or follow us on social media.



Whatever sector you work in,  
the swingo 250µmicro is the floor  
cleaning solution for you.

[www.taski.com](http://www.taski.com)

TASKI is one of four core areas of the Diversey business. All logos and trademarks are owned by or licensed to Diversey, Inc. © 2021 Diversey, Inc. All Rights Reserved. 88927-LIT master (21/147)